

Soft Starters
VS II ... - 3,5 ... 16
Assembly- and Commissioning Instructions



as per 06/20 15700.10020

Table of Contents	Page
1. Safety notes	3
2. Conformity	3
3. General description	4
4. Usage to the intended purpose	4
5. EC Declaration of Conformity	5
6. Block diagram	6
6.1 Configurations options	6
7. Commissioning	6
7.1 Mounting instructions	7
7.2 Connection	8
7.3 Parameter settings	10
7.4 Starting frequency	11
8. Starting and stopping	12
8.1 Soft start	12
8.2 Soft stop	15
9. Control inputs	16
9.1 Standard devices and devices with option „M“	16
9.2 Devices with Option „I“ and „T“	16
9.3 Devices with Option „B“	16
10. LED indicators	17
10.1 Indicating elements	17
10.2 Signalling outputs Option "I" and „T“	17
10.3 Signalling outputs Option "M"	17
11. Fault	18
11.1 Fault description	18
11.2 Fault remedy	19
11.3 Resetting of faults	20
12. Technical data	21
12.1 Environmental conditions	22
13. Dimensioning rules	22
13.1 Dimensioning of fuses for device protection	22
13.2 Determining the permissible starting frequency:	24

14. Special units	26
14.1 Devices with rated voltage of 230V or 480V	26
14.2 Devices featuring a wide-voltage-range power section	26
14.3 Devices with motor-PTC input (Option T, I)	27
15. Installation guideline	28
15.1 Connection	28
15.2 General connection diagram	29
15.3 Typical connections	30
15.4 Motor/Soft start in delta connection (Special unit option M)	31
15.5 Devices with control supply voltage U_s 24VDC	32
16. Dimensions	33

These commissioning instructions were prepared with great care. Nevertheless, PETER electronic GmbH & Co. KG does not assume liability for damage resulting from mistakes possibly contained in this manual. Technical changes that serve to improve the product are subject to change without notice.



Disposal Instructions

Equipment containing electrical components may not be disposed of together with domestic waste. It must be collected separately as electrical and electronic waste according to local and currently valid legislation.

Notes and symbols used in these instructions

Note: Notes explain the advantages of certain adjustments or settings and help you to make use of the device in the best possible way.



Warning notices: Read them carefully and follow them strictly!

Warning notices are indicated in order to protect you against danger or to help you to prevent the device from being damaged.



Caution: Danger to life through electric shock!

When you see this sign, always make sure that the device is de-energized and secured against unintentional energizing.

1. Safety notes



The described devices are electrical equipment for use in industrial electrical power installations. An impermissible removal of the covers during operation can cause serious damage to your health, since these devices contain live parts with high voltages.

Adjustment work may only be performed by trained staff observing the safety regulations. Assembly and mounting work may only be carried out with the equipment deenergized.

Make sure that all drive components are properly earthed.

Please read these commissioning instructions carefully before putting the device into operation.

Besides, the user must ensure that the devices and associated components are fitted and connected in accordance with the applicable local, legal and technical regulations. The VDE-regulations VDE 0100, VDE 0110 (EN 60664), VDE 0160 (EN 50178) , VDE 0113 (EN 60204, EN 61310), VDE 0660 (EN 50274) plus the appropriate regulations of the TÜV (Technical Control Association) and the trade associations apply in Germany.

The user must ensure that the drive turns into a safe operating state following a device failure, in the event of maloperation, or if the control unit has failed etc..

Caution: Even if the motor is at rest, it is **not** physically separated from the mains.

2. Conformity

In industrial linguistic usage the drive controllers of the type series VersiStart II are called "devices", however, in the sense of the "law on the safety of equipment", the "EMC-law" or the "EC-machinery directive" they are not devices or machines ready for use or connection but they are components. It is only possible to define their final function, when these components are integrated into the design and construction of the user.

To be able to use the devices to their intended purpose, it requires power supply networks according to DIN EN 50160 (IEC38).

The user takes the responsibility that the user's design and construction comply with the applicable legal provision.

The commissioning is strictly forbidden as long as the conformity of the final product with the guidelines 2006/42/EC (Machinery directive) and 2006/95/EC (Low voltage directive) is not proved.

3. General description

In the case of the soft starters of the VersiStart II type the motor voltage is changed in two phases (1L1/5L3) by a generalized phase control and power semiconductors. Starting from an adjustable starting trigger angle the trigger angle is continually reduced. Via the adjusted ramp-up time the motor voltage increases according to a ramp function until the maximum value is reached. When the acceleration time is over, the power semiconductors are bypassed by integrated relays and the motor is directly supplied with power from the mains.

After opening of the start/stop-contact, the trigger angle is continuously increased via a ramp-function, and, as a result, the motor voltage is decreased. The motor softly decelerates with the adjusted deceleration time.

Acceleration time, starting voltage and deceleration time can be separately adjusted via potentiometers.

Acceleration or deceleration are effected by closing or opening of the contact on the terminals X1/X2.

The boost function is switched on by bridging the terminals X1/X3. Thus, at the beginning of the soft start, an increased starting voltage is applied to the motor for a period of 0,5s.

The power supply to the control electronics is effected via the power section. On request, the power supply can also be implemented via an external power supply unit (24V min. 150mA DC).

The devices are suitable for an operation of 3-phase motors in star or delta connection. Interconnection of motors in a so-called $\sqrt{3}$ -connection is possible as well.

For $\sqrt{3}$ -connection, it is necessary to use a main contactor K1, since one motor winding lies directly between two phases.

4. Usage to the intended purpose

The devices of the VersiStart II-series are electrical equipment that is used in industrial electrical power installations. They are designed for application in machines, in order to reduce the starting torque and starting current peaks as well as the tripping torque of drives with three-phase induction motors.

Typical Applications:

- door and gate drives
 - pumps, ventilators, fans
 - conveying systems
 - packaging machines
 - transport systems, assembly lines
 - machine applications
-

5. EC Declaration of Conformity

EC Declaration of Conformity 

The manufacturer / company placing the product on the market
(authorized representatives of the manufacturer / companies placing the product on the market
that are established within the Community)

Name / Address: PETER electronic GmbH & Co. KG
Bruckäcker 9
92348 Berg

hereby declares that the following product (device, component, unit) in the version as supplied

Product designation: **Soft starters**
Series / type designation: VS II 230...480-3,5...16; T; I; M; B
Article number: 257...
Year of manufacture: 2013

complies with the provisions of the following EU-directives:

- 2014/30/EU** Electromagnetic compatibility
- 2014/35/EU** Electrical equipment designed for use within certain voltage limits
- 2011/65/EU** The restriction of the use of certain hazardous substances in electrical and electronic equipment

The following harmonized standards have been applied:

- EN 60947-1:2007+A1:2012** Low-voltage switchgear and controlgear General rules
- EN 60947-4-2:2012** Low-voltage switchgear and controlgear
Contactors and motor-starters - AC semiconductor motor
controllers and starters

This EC Declaration of Conformity is no longer valid, if the product is modified or changed
without our agreement.

This declaration is issued under the sole responsibility of the signatory.

Berg, 18.04.2016
(place, date)

Dr. Thomas Stiller, Managing director
(signatory and function of the signatory)

(signature)

6. Block diagram

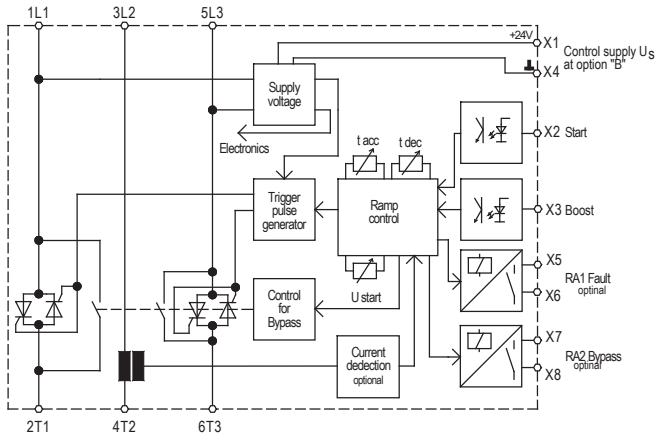

6.1 Configurations options

Type designation	VS II ... - 3,5...16			
	Standard	Option T	Option I	Option M
Signalling relay				
Operational status	-	X	X	X
Fault	-	X	X	X
Input				
Boost	X	-	-	X
Motor PTC	-	X	X	-
Current control	-	-	X	-
heat sink PTC	-	X	X	X

Devices with option „B“ require an external control supply voltage of 24V/300mA.

7. Commissioning

The device is to be put into operation in 3 steps:

1. Mounting
2. Connection and
3. Parameter setting



Please notice the max. permissible starting current (“Technical data” on page 21) .

7.1 Mounting instructions



Caution: Danger to life through electric shock!

The following conditions are to be complied with in order to ensure a safe and reliable operation of the VersiStart II.

1. The device series VersiStart II is to be used under conditions of the overvoltage category III.
2. Make sure that pollution degree 2 or better, in accordance DIN EN60644-1 / IEC664, is complied with.
3. The device has to be installed into a housing (min. degree of protection: IP54). Please take care of a sufficient heat dissipation.
4. The device must be operated without being exposed to contamination by water, oil, carbon deposits, dust, etc..
5. Insert in North America, UL and CSA-listed.
Utilisation en Amérique du Nord, certifié UL et CSA.
- 5.1 Wiring diagram: see Table 15.2, "General connection diagram," on page 29
Schéma de câblage : voir Tableau 14.2, "Schéma de raccordement général", à la page 28.
- 5.2 The terminal tightening torque of lbs-in (Nm): see Table 12, "Technical data," on page 21
Couple de serrage des bornes en lbs-in (Nm) : voir Tableau 11, "Caractéristiques techniques", à la page 20.
- 5.3 To be used in a Pollution Degree 2 environment only.
À utiliser uniquement dans un environnement de degré de pollution 2.
- 5.4 Models VS II f/b -3.5, -6.5, -12 and -16: Suitable for use on a circuit capable of delivering not more than 5kA rms symmetrical Amperes, 480 Volts maximum and when protected by class RK5 fuse rated: see page 23 „Short circuit protection according to UL 508 (Class RK5 fuse)“
Modèles VS II f/b -3.5, -6.5, -12 et -16 : peut être utilisé sur un circuit capable de fournir un courant RMS symétrique de 5 kA maximum, 480 volts maximum et si protégé par un fusible de classe RK5 de : voir page 22 "Protection contre les courts-circuits homologuée UL 508 (fusible de classe RK5) "
- 5.5 Surrounding temperature max. 45°C
Température ambiante 45 °C max.
- 5.6 Use copper conductors 60/75°C, or 75°C only
Utiliser des conducteurs en cuivre avec une résistance thermique de 60/75 °C, ou 75 °C uniquement.
- 5.7 Models with suffix BUc24VDC or BIUc24VDC - marking for external control voltage: Connect only to isolated power supply rated 24VDC. Fuse in accordance to UL248 rated max. 4A shall be installed between the source and input terminal of the unit, or equivalent wording.

Modèles avec suffixe BUc24VDC ou BIUc24VDC - signalant la tension de contrôle externe : connecté uniquement à une alimentation isolée de 24 VDC. Le fusible homologué UL248 de 4A max. doit être installé entre la source et la borne d'entrée de l'unité, ou équivalent.

Place the device vertically on a perpendicular mounting plate with the motor terminals pointing downwards. The device is to be snap-mounted onto a 35mm top-hat rail according to DIN EN 50022. Underneath the device, no additional heat sources such as heating resistors must be mounted or arranged.

7.2 Connection

Power section (see also connection diagram)

Terminal 1L1:	Mains voltage L1
Terminal 3L2:	Mains voltage L2
Terminal 5L3:	Mains voltage L3
Terminal 2T1:	Motor terminal U
Terminal 4T2:	Motor terminal V
Terminal 6T3:	Motor terminal W

Control section

1. Standard

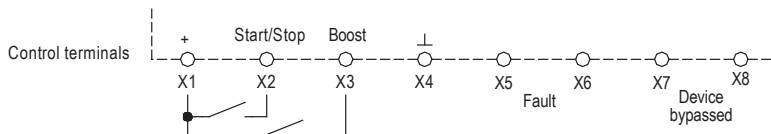

2. Option T, I, M

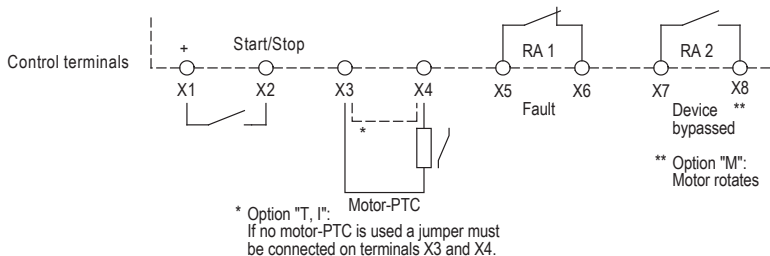

The input resistance of the control inputs is ca. 10kOhm. To control them, it is necessary to use switching contacts enabling reliable switching of the lower control currents (e.g., AgNi+Au)!

If the contact on the terminals X1 a. X2 is closed, the motor accelerates with the adjusted acceleration time ramp. When the contact is open, the motor decelerates with the adjusted deceleration time ramp.

**Caution: Danger to life through electric shock!**

The motor is **not** physically separated from the mains.

Alternatively, the device can also be controlled with d.c. voltage.

If only soft starts are required, VersiStart II may also be controlled via the main contactor. For this purpose, the terminals X1 and X2 have to be bridged.

Adjusting the control type

Devices of the VersiStart II series may be controlled by two types of control.



1. Control with a switching contact or switching transistor between terminal X1 and X2.
2. Control by d.c. voltage 10 ... 24VDC between terminals X2 and X4.

Control supply voltage U_S only in the case of wide-voltage devices (option B)



Between the terminals X1 (+) and X4 (\perp) an auxiliary voltage of 24VDC $\pm 10\%$ /150mA is to be injected.

7.3 Parameter settings

On the front panel there are 3 potentiometers by means of which the following settings can be made.

Parameter	Poti	Setting range
Acceleration time	t_{acc} 	Acceleration time adjustable from 0.5...10sec
Starting voltage	U_{Start}	40...80% of rated voltage
Deceleration time	t_{dec} 	adjustable from 0.25...10sec

Default setting of potentiometers

Potentiometer	t_{acc} 	: 50%	= mid-position
Potentiometer	U_{Start}	: 0%	= left stop (counter-clockwise)
Potentiometer	t_{dec} 	: 0%	= left stop (counter-clockwise)

Only devices with Option I

Parameter	Poti	Setting range
Rate of rise	t_{int}	0...100% Rate of rise of current
Current limit	xI_e	2...5 x Rated device current
Deceleration time	t_{dec} 	adjustable from 0.25...10s

Default setting of potentiometers (Option I)

Potentiometer	t_{int}	: 50%	= mid-position
Potentiometer	xI_e	: 3,5	= left stop (counter-clockwise)
Potentiometer	t_{dec} 	: 0%	= left stop (counter-clockwise)

7.4 Starting frequency

It must be possible for the device or rather the power semiconductors to cool off sufficiently between two starts.

If starts are carried out in too quick succession, there is the danger of thermally overloading and thus destroying the power semiconductors. In this case, the thermal monitoring function of the heat sink will not respond, as it requires some time until the heat loss of the power semiconductors is dissipated into the heat sink. So, if the time interval between starts is too short, the heat sink monitoring function is not able to keep up with the temperature rise of the semiconductors.

Operating the device for a long time in bypassed condition also will cause the power semiconductors to cool off. Starting from a given starting time and starting current, it is possible with the diagrams under section 12.2 to determine the maximum starting frequency per hour. With this value, the required cooling time can be determined.



Warning:

If the time interval between starts is too short, there is the danger of damaging or destroying the power semiconductors.

8. Starting and stopping

8.1 Soft start

With VersiStart II devices, different starting methods can be selected:

1. Voltage ramp: in the case of VS II 400-3,5...16 not option „I“
2. Boost function: in the case of VS II 400-3,5...16 not option „I“ and „T“
3. Current limit $xI_e = 2...5$ - in the case of VS II 400-3,5...16 with Option „I“

1. Start with voltage ramp:

In this case, motor starting is time-controlled, with a voltage ramp adjustable within a range from t_{ramp} 0,5s to 10s and a starting voltage U_{Start} adjustable between 40% to 80% of the rated voltage.

To adjust an optimum starting behavior, you should carry out a test run. Contrary to the factory settings, you should make the following basic potentiometer-settings:

Fans, roller tracks, conveyor belts, etc.	t_{ramp} 50%, U_{Start} 0%, t_{stop} 0%
Centrifuges, conveyor screws, mixers, compressors, etc.	t_{ramp} 50%, U_{Start} 50%, t_{stop} 50%
Pressure pumps, etc.	t_{ramp} 50%, U_{Start} 50%, t_{stop} 50%

Switch on the supply voltage and start acceleration. Watch the starting behavior and adapt the appropriate parameters to your drive. At any rate, the starting voltage should be adjusted with the potentiometer U_{Start} so that the motor starts immediately. At the same time, unnecessary humming with the motor being at rest is to be avoided.

The potentiometer t_{ramp} is to be adjusted so that the requested acceleration time or starting characteristics is achieved. The acceleration time should always be chosen as short as possible, in order to keep the thermal stress acting on device and motor as small as possible. This leads to short times until the bypass relays pull in and ensures good acceleration characteristics while the power semiconductors and motor are less heated. This is of special importance in the case of high-inertia starting or high switching frequencies. The acceleration time, however, has to be adjusted so that the motor reaches nominal speed before the internal bypass relays close

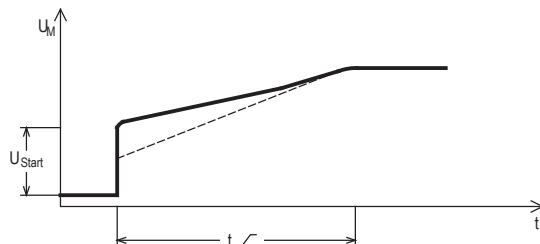

2. Start with boost function:

If a voltage between 24V ...230VAC/DC is applied to the terminals X1 and X3 (not option „I“, „T“), the device will switch into the "Soft start with boost" function. At the beginning of soft start, the motor voltage will, for a short pulse (500ms), be increased to 85% of the rated voltage.

This function brings about an increased breakaway torque for the drive and allows starting of drives having a high holding torque at standstill.

Afterwards, soft start will be continued with the adjusted voltage ramp

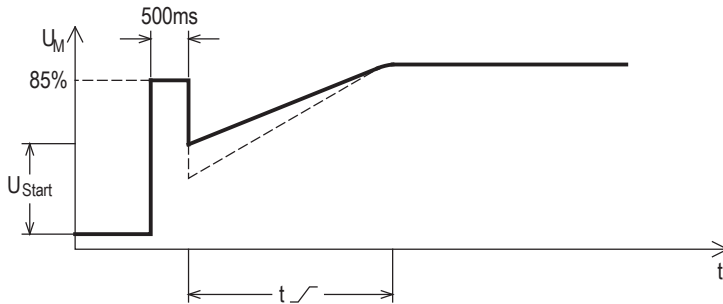

Warning:

If the adjusted acceleration time is too short, the internal bypass relays close **before** the motor has reached nominal speed. This can cause damage to the bypass relays.

3. Start with current limit: - Only in the case of VS II 400-3,5...16 with Option "I"

At the adjusted current limit $x_{le} 2...5$, the motor will be accelerated to rated motor speed. For this purpose, the required starting current is to be set with the potentiometer x_{le} in relation to the rated device current.

With the potentiometer t_{int} , it is possible to adjust the rate of rise of current and thus to adapt the control characteristics and the motor acceleration to the drive. The adjustment range of this potentiometer is 0...100%. This complies with a time range of 0.1...1s.

The motor current is measured in the uncontrolled phase L2/T2 which, in the case of two-phase-controlled soft starters, carries the highest current due to technical reasons. The adjusted current limit relates to the motor current in phase L2/T2. In the two other motor phases, the current is lower by up to approx. 35%.

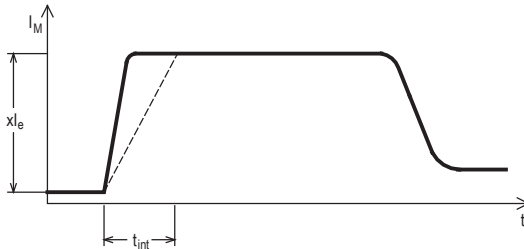

Warning:

If the current limit is set to a value too low, the motor will not accelerate to full speed and will remain at an intermediate speed. After some time, see diagram „Timeout“, the device will stop the starting process and go into fault mode in order to not overload the device and motor.

When selecting the current limit, it is important to consider load changes, e.g., over the course of time (mechanical alterations, wear and tear, ...) or thermal variations, etc... . The setting should be such that, even under worst case conditions, the drive accelerates to full speed without any problems.

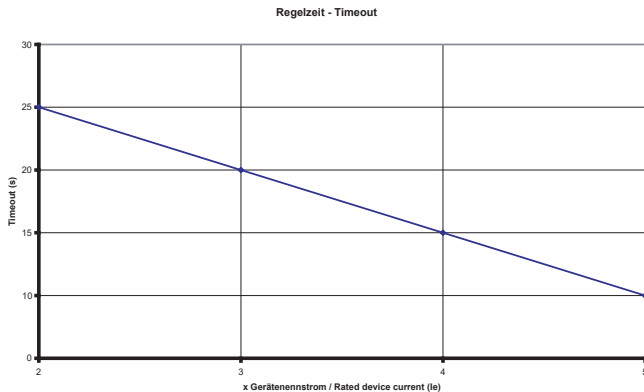

8.2 Soft stop

Note: Soft stop is only useful for pump drives or applications in the case of which the drive comes to a stop **immediately** after switch off. In the case of drives driving high-inertia loads, soft stop is not sensible.

Hinweis: To enable soft stop, the VersiStart II, during the deceleration phase, has to be supplied with power from the supply mains.

In the case of these devices, the cut-off voltage is factory-set to 70%.

The potentiometer t_{\sim} is to be adjusted so that the requested deceleration time or deceleration characteristic is reached.



Caution: Danger to life through electric shock!

Even if the motor is at rest, it is not physically separated from the mains.



Warning!

Make sure that the specified switching frequency is not exceeded! After every start, it is necessary to give the power semiconductors sufficient time to cool down. If the time interval between starts is too short, there is the danger of destroying the power semiconductors!

Operation in bypassed condition also allows the power semiconductors to cool down!

Note: If, in the motor circuit, a motor contactor that closes with the starting contact is used, the deceleration time t_{\sim} is to be set to 0%.

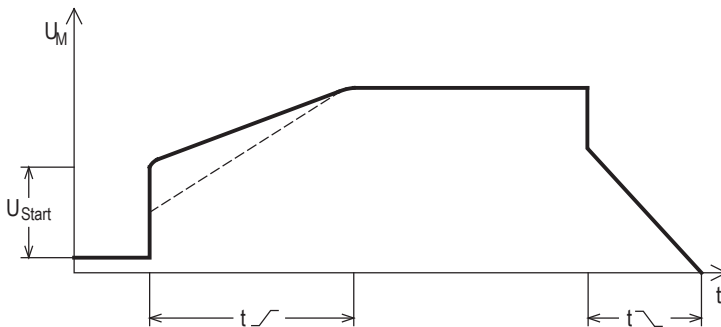

9. Control inputs

9.1 Standard devices and devices with option „M“

Control terminal X1: Output - control voltage 24V/10mA

Control terminal X2: Input - start/stop

Control terminal X3: Input - boost function

Control terminal X4: control voltage ⊥

9.2 Devices with Option „I“ and „T“

Control terminal X1: Output - control voltage 24V/10mA

Control terminal X2: Input - start/stop

Control terminal X3: Input - motor-PTC

Control terminal X4: control voltage and motor-PTC ⊥

9.3 Devices with Option „B“

Control terminal X1: Input - control supply 24V/300mA

Control terminal X2: see point 9.1 or 9.2

Control terminal X3: see point 9.1 or 9.2

Control terminal X4: control supply ⊥

10. LED indicators

10.1 Indicating elements

On the device front panel there are 2 light-emitting diodes indicating the following operational states:

LED	Operational status
Green	Device is connected to mains voltage
Yellow	Start completed, device bypassed
Yellow - flashing with increasing or decreasing frequency	Soft start / Soft stop
Yellow - flashing with constant frequency	Fault

10.2 Signalling outputs Option "I" and „T“

On the control terminals X5 / X6 (RA 1) and X7 / X8 (RA 2) two relay contacts are available which signal the following operational states::

RA 1 **Fault**

Under normal operating conditions the signaling contact RA 1 is closed, it only opens if a fault occurs.

RA 2 **Device bypassed.**

When the start-up ramp is over and the motor is supplied with nominal voltage or the bypass relays are closed, the signaling contact RA 2 will be closed.

10.3 Signalling outputs Option "M"

On the control terminals X5 / X6 (RA 1) and X7 / X8 (RA 2), two relay contacts signalling the following operational statuses are available:

RA 1 **Fault**

Under normal operating conditions the signaling contact RA 1 is closed, it only opens if a fault occurs.

RA 2 **Motor rotates**

At the beginning of the soft start function, the signalling contact RA2 is closed and remains closed until the end of the soft stop function.

11. Fault

The device series VersiStart II monitors various fault conditions. If a fault is detected, the device signals the fault with the yellow LED (flashing at constant frequency). In the case of a fault, the signaling relay RA 1 is opened. The various fault conditions are indicated via different flashing frequencies of the yellow LED.

11.1 Fault description

Fault	LED	Operational status
1	Yellow LED flashes 1x with a short pause	Power failure / Undervoltage of electronics supply
2	Yellow LED flashes 2x with a short pause	Heat sink temperature too high/device thermally overloaded (please also take note of "Starting frequency" on page 11) or motor temperature too high (If a motor-PTC is connected „Option T, I and M“)
3	Yellow LED flashes 3x with a short pause	Timeout Current control
4	Yellow LED flashes 4x with a short pause	Failure Mains zero crossings -> Mains or motor circuit is defective
5	Yellow LED flashes 5x with a short pause	Phase failure in phase 1
6	Yellow LED flashes 6x with a short pause	Phase failure in phase 2
7	Yellow LED flashes 7x with a short pause	Phase failure in phase 3
8	Yellow LED flashes 8x with a short pause	Trigger failure in phase 1
9	Yellow LED flashes 10x with a short pause	Trigger failure in phase 3
10	Yellow LED flashes 11x with a short pause	Electronics failure
11	Yellow LED flashes 12x with a short pause	Motor current lower than 0,125 x rated device current

11.2 Fault remedy

In case of a fault, please proceed as follows:

- Fault 1: A Power failure was detected. Test the mains supply on terminals L1, L2 and L3. Or a defect in the internal control electronics. Send the device to the producer to have it checked.
- Fault 2: Check the starting frequency and the starting current, and also observe the max. ambient temperature. Give the device enough time to cool down. Heat dissipation can be improved by forced cooling, with of a fan mounted underneath the device. If a motor-PTC is connected, see "Devices with motor-PTC input (Option T, I)" on page 27.
- Fault 3: The motor does not reach final speed with the adjusted max. starting current. Increase the value of the starting current with the "I" potentiometer.



Caution!

After a timeout cutoff, always allow the device and motor to cool down, as an immediate restart may destroy the device.

- Fault 4-7: Power supply failed, motor lead interrupted, power semiconductor(s) defective, motor defective. Check motor and wiring. Send the device to the producer to have it inspected.
- Fault 8-9: Check the motor cabling; or thyristor module defective. Send the device to the producer to have it repaired.
- Fault 10: Have the device checked by the producer.
- Fault 11: Motor is too small or phase failure. Check whether the motor fits the device or the wiring.
-

11.3 Resetting of faults

There are two ways available to reset a device fault.

1. In as-delivered condition, the fault message can be reset by disconnecting and reconnecting the supply voltage. In the case of standard devices via L1, L2 and L3, and in devices with option "B" via 24VDC.
2. The device can be programmed such that a fault reset is possible through a restart (opening and closing of the start input). For this, it is necessary to proceed as follows.

First of all, the device has to be wired in compliance with the following connection diagrams.

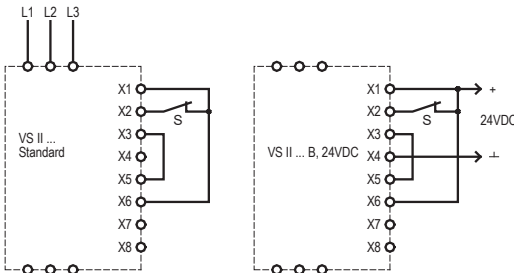

Afterwards, the supply voltage is to be switched on. No motor must be connected! In the case of standard devices via L1, L2 and L3; and in devices with option "B" via 24VDC or 230VAC. After a short period of time, the yellow LED flashes with a different frequency, depending on the reset mode adjusted.

- | | |
|----------------------|---|
| Low flash frequency | -> Fault reset by switching the supply voltage on and off (standard setting). |
| High flash frequency | -> Fault reset through restart. |

The reset mode can be changed by opening and closing the start input (switch „S“); the yellow LED blinks with the corresponding flash frequency, and the new mode is permanently stored.

Now, the supply voltage can be switched off again and the device is ready for installation in its application.



Warning:

At any rate, the cause of the fault has to be identified and remedied by trained and qualified personnel. Only then must the device be put into operation again.

12. Technical data

Type designation	VS II 400-..			
	3,5	6,5	12	16
Rated device current	3.5A	6.5A	12A	16A
Rated operational voltage U_e	400V \pm 10% 50/60Hz			
Control supply voltage U_S only with Option B	24V \pm 10% DC / 300mA			
Motor rating at U_e 400V	1.5kW	3kW	5.5kW	7.5kW
Motor rating at U_e 400V IE3 Motors	1.1kW	2.2kW	4kW	5.5kW
Switch. frequency/hour at $3xI_N$ and $t_{an}=5s$	150	70	30	15
Utilization category	3.5A:AC-53b:6-3:55	6.5A:AC-53b:6-3:115	12A:AC-53b:6-3:295	16A:AC-53b:6-3:595
max. Power dissipation				
- in operation related to max. starting frequency	11W	10W	9W	7W
- Standby	2.5W	2.5W	2.5W	2.5W
I^2t - Power semiconductors	390A ² s	390A ² s	720A ² s	720A ² s
min. Motor load	20% of the device rated current			
Starting time	0.5 ... 10s			
Starting voltage	40 ... 80% of rated voltage			
Stopping time	0.25 ... 10s			
Restart time	300ms			
Input resistance Control inputs	10kOhm			
Contact rating of Relay outputs RA1 / RA2	2A / 250VAC / 30VDC			
Overvoltage category / Pollution degree:				
Control and auxiliary circuit	II / 2			
Main circuit	III (TT / TN-Netze) / 2			
Rated impulse strength U_{imp} :				
Control and auxiliary circuit	2.5kV			
Main circuit	4kV			
Rated insulation voltage U_i :				
Control and auxiliary circuit	500V			
Main circuit	250V			
max. Cross-sectional area for connection:				
Control terminals	1.5mm ² / AWG 16			
Power terminals	2.5mm ² / AWG 14			
max. Tightening torque:				
Control terminals	0.6 Nm / 5 lbs in			
Power terminals	0.6 Nm / 5 lbs in			
Weight	400g			
Special voltages (optional)	230V / 480V / wide-voltage range 200-480V with ext. control supply voltage 24VDC			

12.1 Environmental conditions

Storage temperature	-25 ... 85°C
Ambient temperature	0 ... 45°C up to an installation altitude of 1000m, not exposed to moisture condensation
Power reduction ¹⁾	above 45°C - 2% per 1°C up to max. 60°C and altitudes above 1000m -2% per 100m
Degree of protection	IP 20
Environment	Overvoltage categ. III (TT / TN-systems) pollution degree 2
Installation class	4

¹⁾ The reductions refer to rated power output.

Note: Please pay attention and consider for the operation of IE3 motors while dimensioning of softstarters the resulting higher starting currents.
For the use of IE3 motors we highly recommend to dimension and design the needed softstarters one size higher.

13. Dimensioning rules

13.1 Dimensioning of fuses for device protection

Pre-fuses F can be dimensioned according to the following instructions.

Basically, two types of fuse protection are available for the user.

1. Fusing according to allocation type „1“, DIN EN 60947-4-2.
After a short circuit, the VersiStart II device is allowed to be inoperative and repair work is possible.
2. Fusing according to allocation type „2“, DIN EN 60947-4-2.
After a short circuit, the device must be suitable for further use. However, there is the danger that the contacts of the bypass or braking relays weld. Therefore, if possible, these contacts are to be checked prior to reconnecting these contacts to the mains supply. If this check cannot be carried out by the user, the device has to be returned to the producer in order to have it checked.

The following dimensioning information refers to the below operating conditions:

- Use of standard asynchronous motors
- Standard acceleration and/or deceleration times
- Switching frequencies not exceeding the values specified in the data sheet

Fusing according to coordination class "1"

As pre-fuses, we recommend to use fuses of the utilization category gG.

If such fuses are also used to provide line protection, the conductor cross section is to be appropriately coordinated!

Short circuit protection according to EN 60947-4-2

Rated device current (techn. data)	Device type	Fuse value in the case of allocation type 1	Fuse type (recommendation)
3.5A	VS II ...-3,5	10A	500V NH0gG
6.5A	VS II ...-6,5	16A	500V NH0gG
12A	VS II ...-12	25A	500V NH0gG
16A	VS II ...-16	35A	500V NH0gG

Short circuit protection according to UL 508 (Class RK5 fuse)

Model	Max. fuse rating
VS II xxx-3.5	8A
VS II xxx-6.5	12A
VS II xxx-12	15A
VS II xxx-16	20A

Fusing according to allocation type „2“:

The power semiconductors are to be protected by semiconductor protection fuses of the utilization class aR or gR . aR fuses do not guarantee line protection, additional line protection fuses (utilization category gG) must be used.

To protect the semiconductors it is necessary to select fuses featuring cutoff- I^2t -values which are approx. 10-15% below the threshold I^2t -value of the power semiconductor (see technical data). In this connection, the fuse rating of the selected fuse should not be smaller than the starting current to be expected.

Note:

1. PETER electronic does not prescribe the use of semiconductor protection fuses. However, for some UL- or CSA-listed devices there are exceptions which are indicated in the relevant commissioning instructions.
2. On the basis of the I^2t -value of the power semiconductors, the starting time and possibly the max. starting current, the fuse supplier is able to select a suitable type. Due to the great variety of producers, sizes and types, PETER electronic does not recommend any particular fuses.
3. If the value of the fuse or the cutoff- I^2t -value is selected too small, it may happen that the semiconductor fuse reacts during the starting phase or during deceleration.

13.2 Determining the permissible starting frequency:

The starting frequency depends on the:

1. starting current or the heat loss across the power semiconductors.
2. ambient temperature.
3. current carrying capacity and the temperature increase of the power semiconductors.
4. heat sink's capability of absorbing the heat loss and passing the temperature increase on to the environment.

The following diagrams are to assist you in determining the maximum starting frequency per hour, i.e., on the basis of the given maximum starting current and for various starting times.

Should the requested starting frequency not be reached, a different device series has to be chosen.

Example: In a drive, a 5.5 kW-motor is to be started. A maximum starting current of 44A has been measured. This approximately corresponds to the 4-fold nominal current. The device employed is a VS II 400-12. From the applicable chart it is now possible to read off a max. starting frequency per hour lying between 84 (starting time = 1s) and 8 (starting time = 10S).

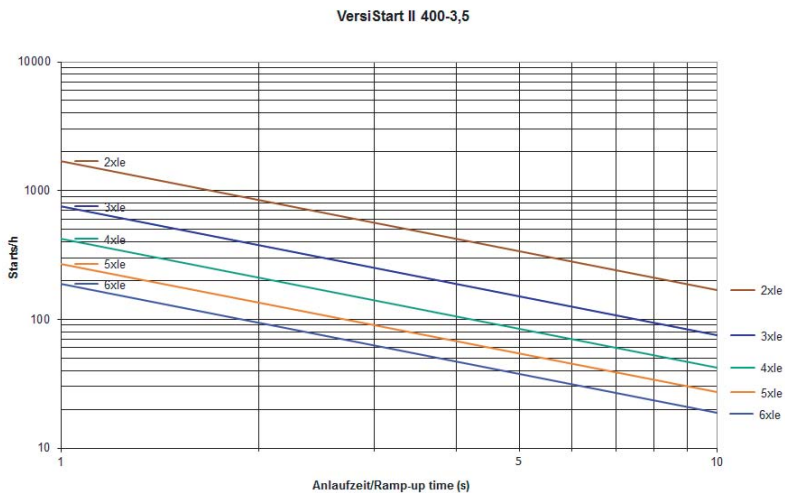

VersiStart II 400-6,5

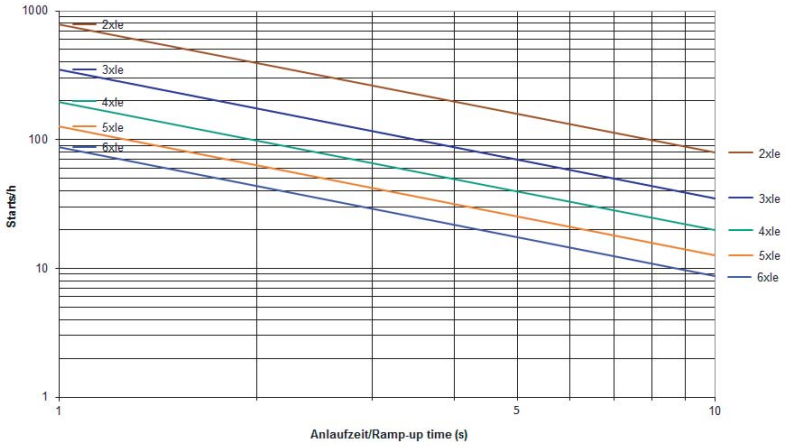

VersiStart II 400-12

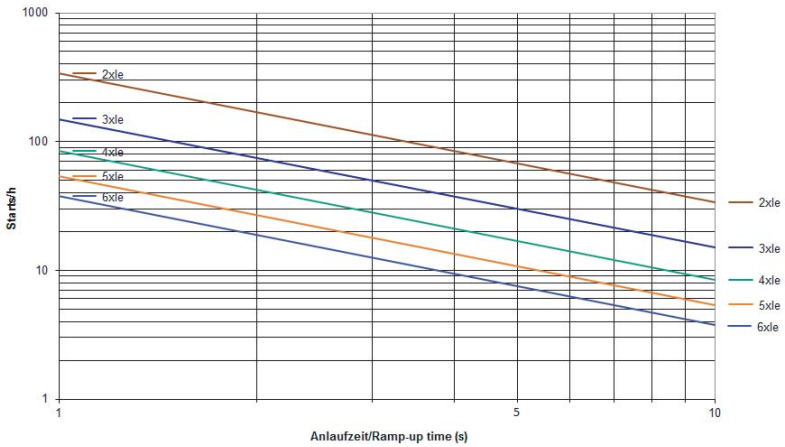

VersiStart II 400-16

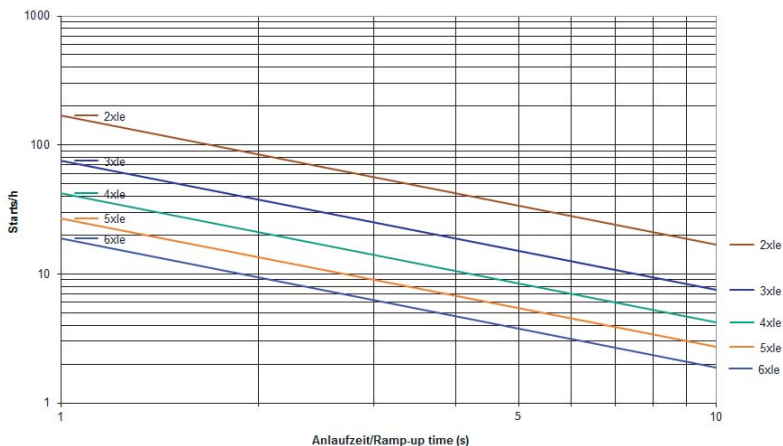

14. Special units

The rated voltage of a device featuring special voltage is indicated on the rating plate. In the case of devices with voltages < 400V it must be ensured that the device rating and the motor rating are not identical. Of prime importance in this connection is the rated device current and the motor current according to rating plate.

14.1 Devices with rated voltage of 230V or 480V

It must be ensured that the mains voltage value indicated on the rating plate is connected to the terminals L1, L2, L3.

Otherwise the devices are to be put into operation like standard devices.

14.2 Devices featuring a wide-voltage-range power section

In the case of wide-voltage-range-capable devices the voltage range for the power supply is 200V ... 480V. Besides, in order to operate the devices, it is necessary to connect an control supply voltage U_S of 24VDC $\pm 10\%$ /150mA to the terminals X1 (+24V) and X4 (ground).



Caution!

These devices must be reseted by disconnect the control supply voltage U_S .
Otherwise the devices are to be put into operation like standard devices.

14.3 Devices with motor-PTC input (Option T, I)

In the case of these devices, it is possible to connect a motor-PTC for motor temperature monitoring. The sensor lines of the motor-PTC are to be connected to the terminals X5 and X6 (⊥).

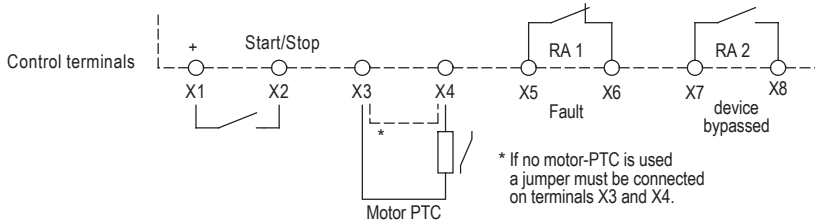

If the motor temperature exceeds the switching threshold, the motor PTC triggers a fault. The soft starter switches the motor off and is interlocked in fault mode. The fault is signaled by the yellow LED repeatedly flashing two times and by an opening of the relay contact between the terminals X5 and X6.

Let the motor cool down, identify the root cause and remove the cause of the intense heating up of the motor. By switching the supply voltage OFF, the soft starter will be reset from fault mode into operating mode.



Attention!

To avoid EMI couplings into the electronics and their disturbances they involve, it is not allowed to use free, unshielded strands in the motor cable for connecting the temperature sensor to the soft starter.

The temperature sensor should be connected with the soft starter by a separate, and preferably, shielded cable. The line ends are to be neatly terminated and unshielded lines must be kept as short as possible.

The sensor cable is, as far as possible, to be laid separately from the power cables in separate cable ducts. If crossings of power cables and control cables are inevitable, they should be arranged at an angle of 90°.

15. Installation guideline

The devices are to be installed into a switchbox or switchgear cabinet according to point 7. It must be ensured that the switchbox/switchgear cabinet is capable of dissipating the occurring heat loss (see techn. data).

15.1 Connection

The device is to be installed according to the attached connection diagram. For other connections please consult PETER electronic GmbH & Co. KG.

15.1.1 Grounding

A proper electrical grounding provided ensures a low impedance connection between all metallic surfaces. Apart providing a degree of electrical safety and isolation, the grounding also has the beneficial effect that the flow of RF currents can be directed through the structure of the equipment rather than through sensitive circuits, where it could be disruptive. It is for this reason that it is vitally important to provide separate earth conductors for each part of the installation all connected to a common star point.

15.1.2 Wiring

To avoid EMI couplings into the electronics and the disturbances they involve, it must be ensured that the control lines routed separately in separate cable ducts and as far as possible away from the power cables. If control lines crossing power lines, they have to be laid at an angle of 90° (Figure 1).

When connection shielded cables make sure that the unshielded cable ends are as short as possible. The large-surface shield bonding must not necessarily be located on the end of the shielding but may also be established in a suitable place - at a distance of some centimetres. The shield must always be connected on both ends to ground (Figure 2).

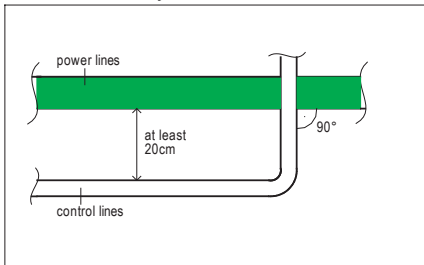

Figure 1

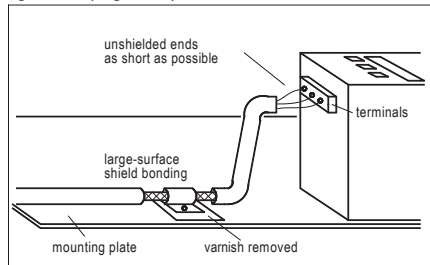

Figure 2



Caution!

The protective conductor connection to the motor must not be laid in shielded motor cables, but is to be separately laid with an appropriate cross-sectional area. The individual earthing systems, power earth, protective earth, digital earth, and analog earth conductors should be laid separately by using a suitable star-point wiring.

Note: Further connection diagrams for special circuit arrangements are available on our homepage at www.peter-electronic.com.

Note: Prior to putting the VersiStart II into operation the wiring is to be checked.

15.2 General connection diagram

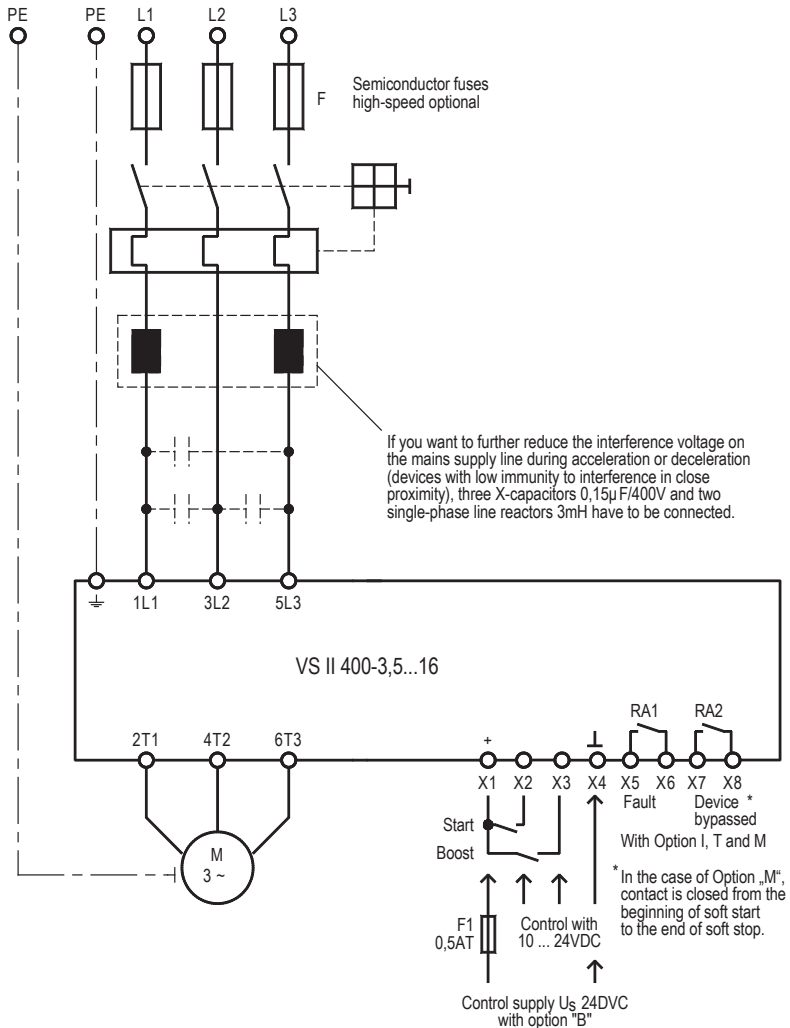

15.3 Typical connections

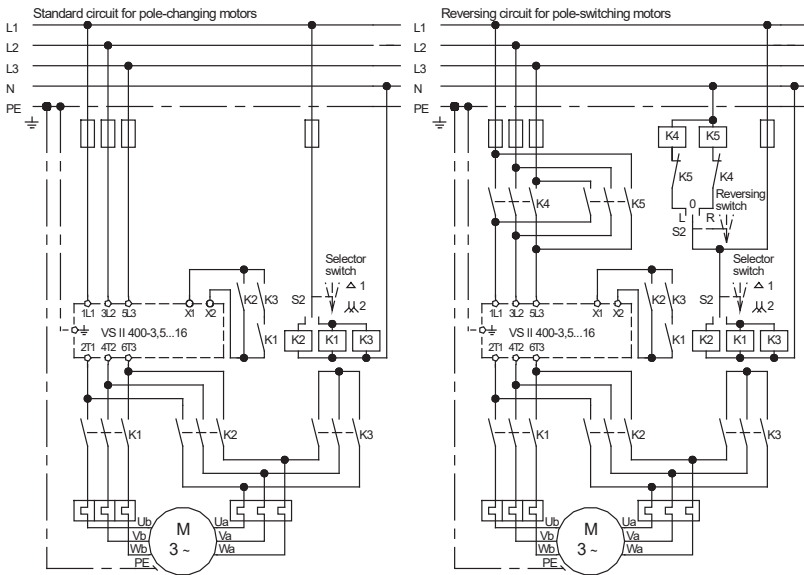
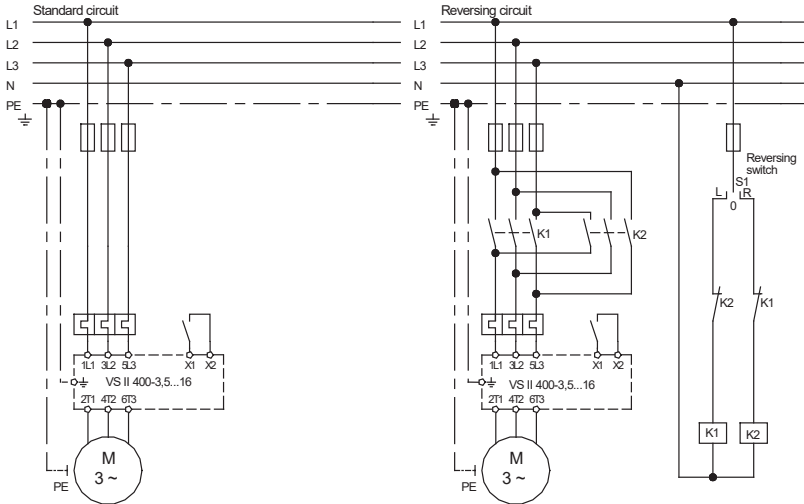

Further connection diagrams are available via the internet at www.peter-electronic.com

15.4 Motor/Soft start in delta connection (Special unit option M)

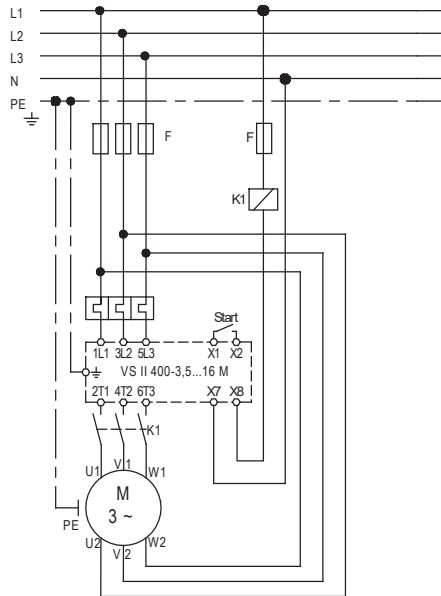

15.5 Devices with control supply voltage U_s 24VDC

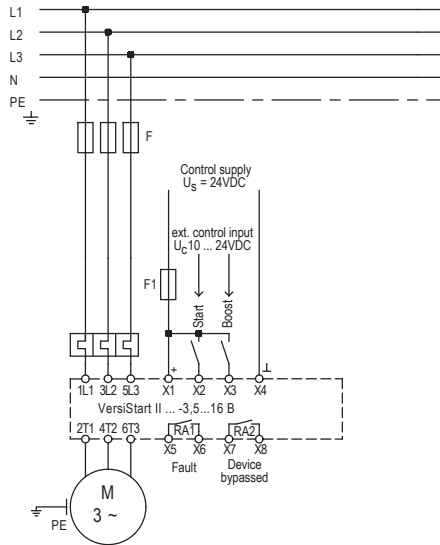

Weitere Anschlussbeispiele finden Sie im Internet unter www.peter-electronic.com

16. Dimensions

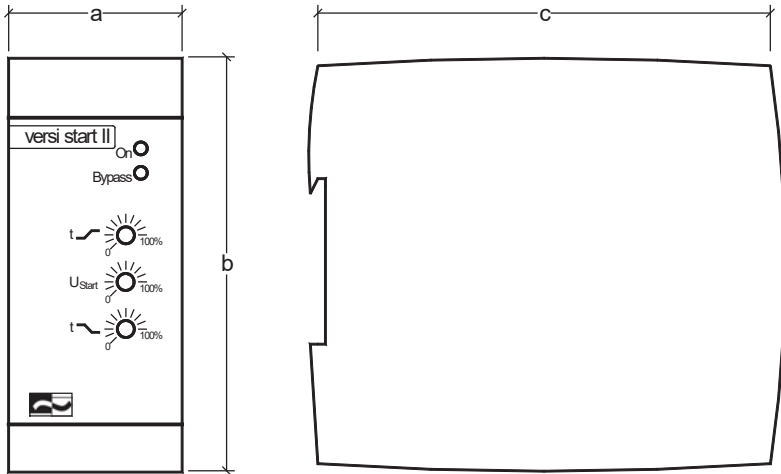

Mounting dimensions	a	b	c
VS II ...-3,5...16	45	110	121

All dimensions indicated in mm.



www.peter-electronic.com

